

The information included in this document is proprietary and shall not be reproduced, transferred, or disclosed to others, for any purpose whatsoever, without the written authorization of Quantum Design and Technologies Inc.

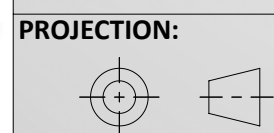

SHEET SIZE:  
**C**

DRAWN:	<b>TP</b>	PROJECT NAME:	<b>HEX FIREPIT</b>		WT:	<b>125.8 lbs</b>
CHECKED:	<b>NB</b>	PROJECT #:	<b>QTMP 21-002</b>	FINISH:	<b>HIGH HEAT BBQ PAINT</b>	
APP:	<b>NB</b>	TITLE:	<b>RENDER CRAB</b>			
DATE:	<b>2021-12-20</b>	SHEET 1 OF 3	DWG #:	<b>QTMP 21-002 - 1</b>		REV: <b>0</b>

ALL DIMENSIONS IN INCHES UNLESS OTHERWISE NOTED



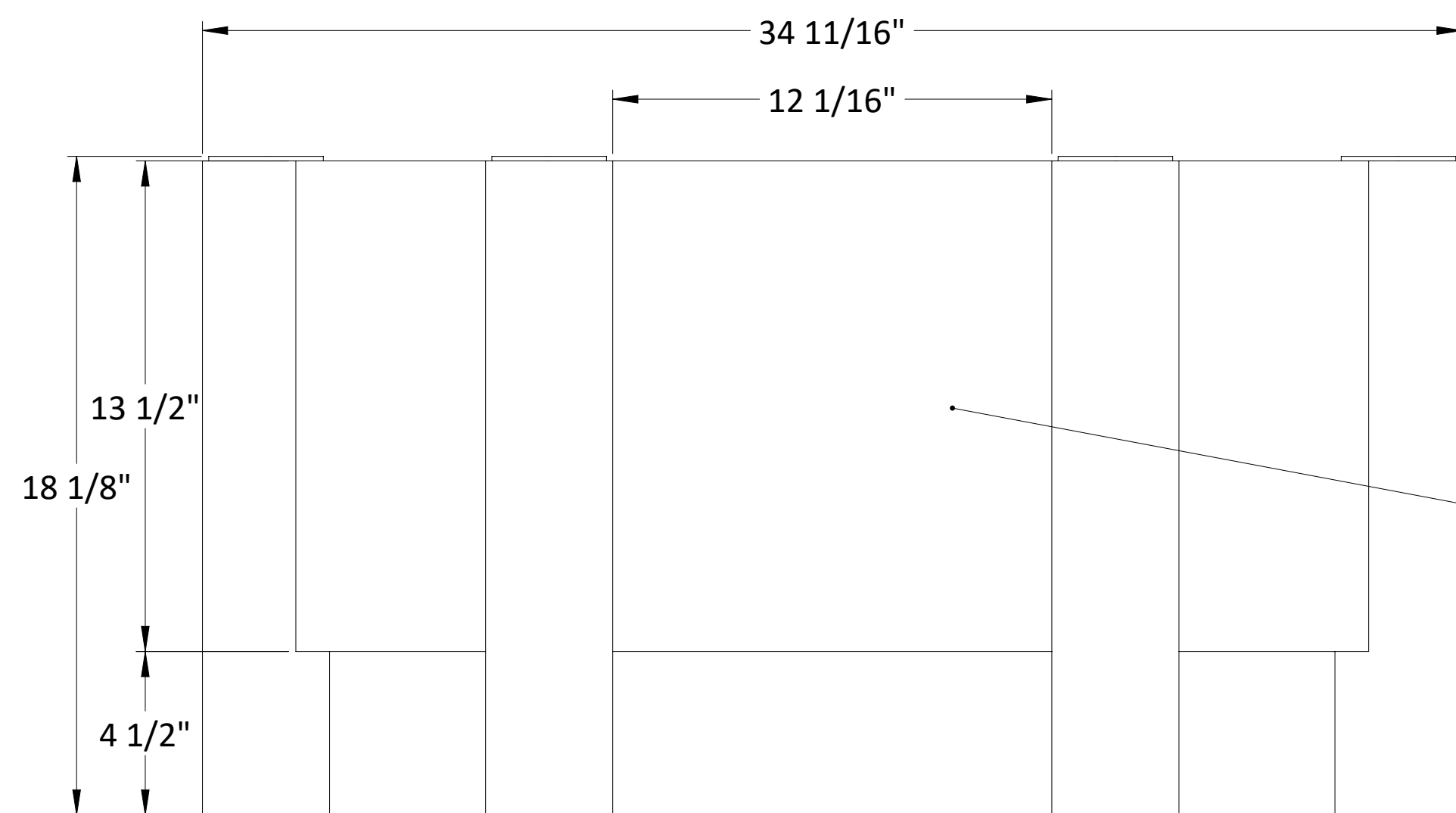
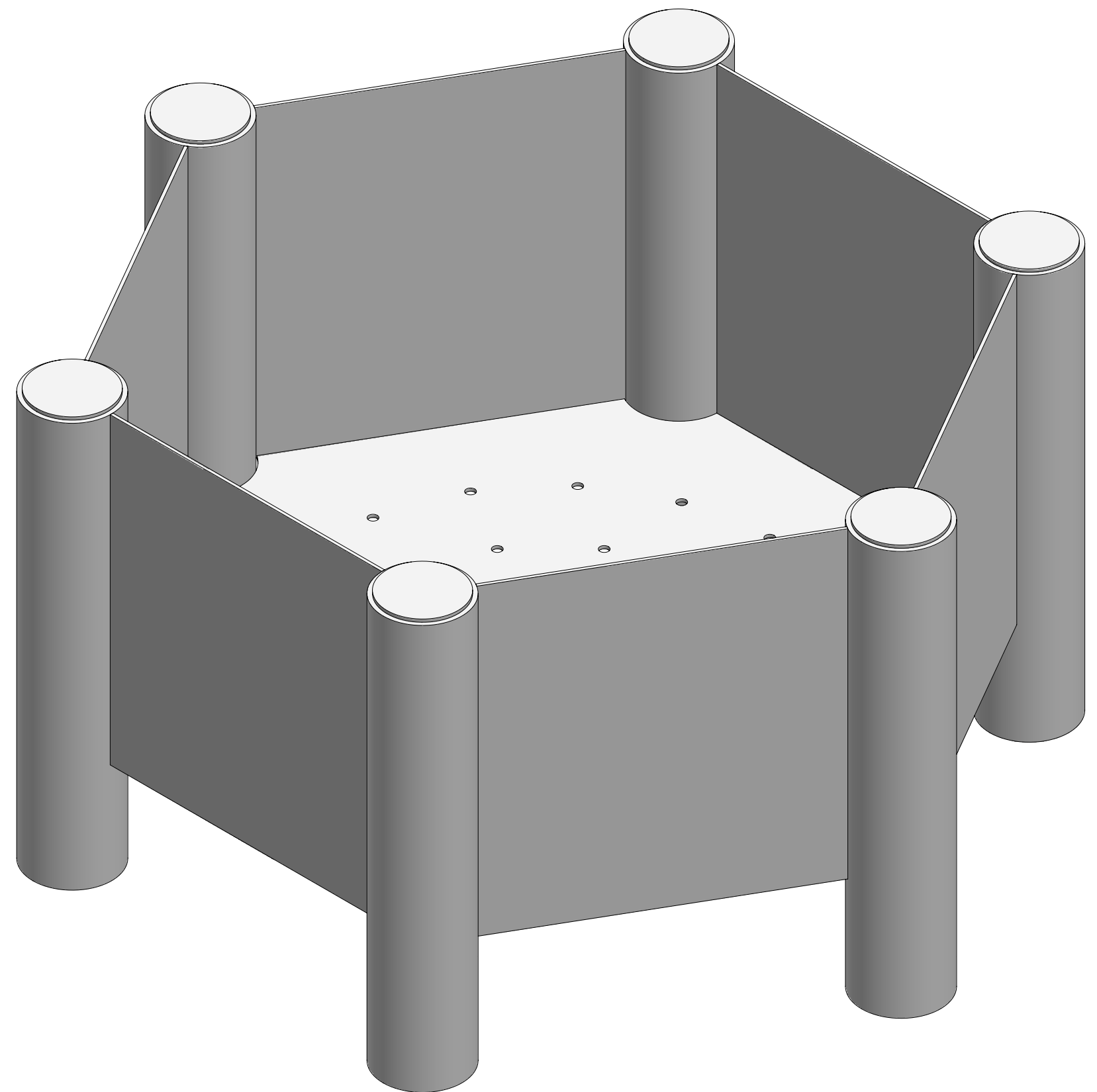
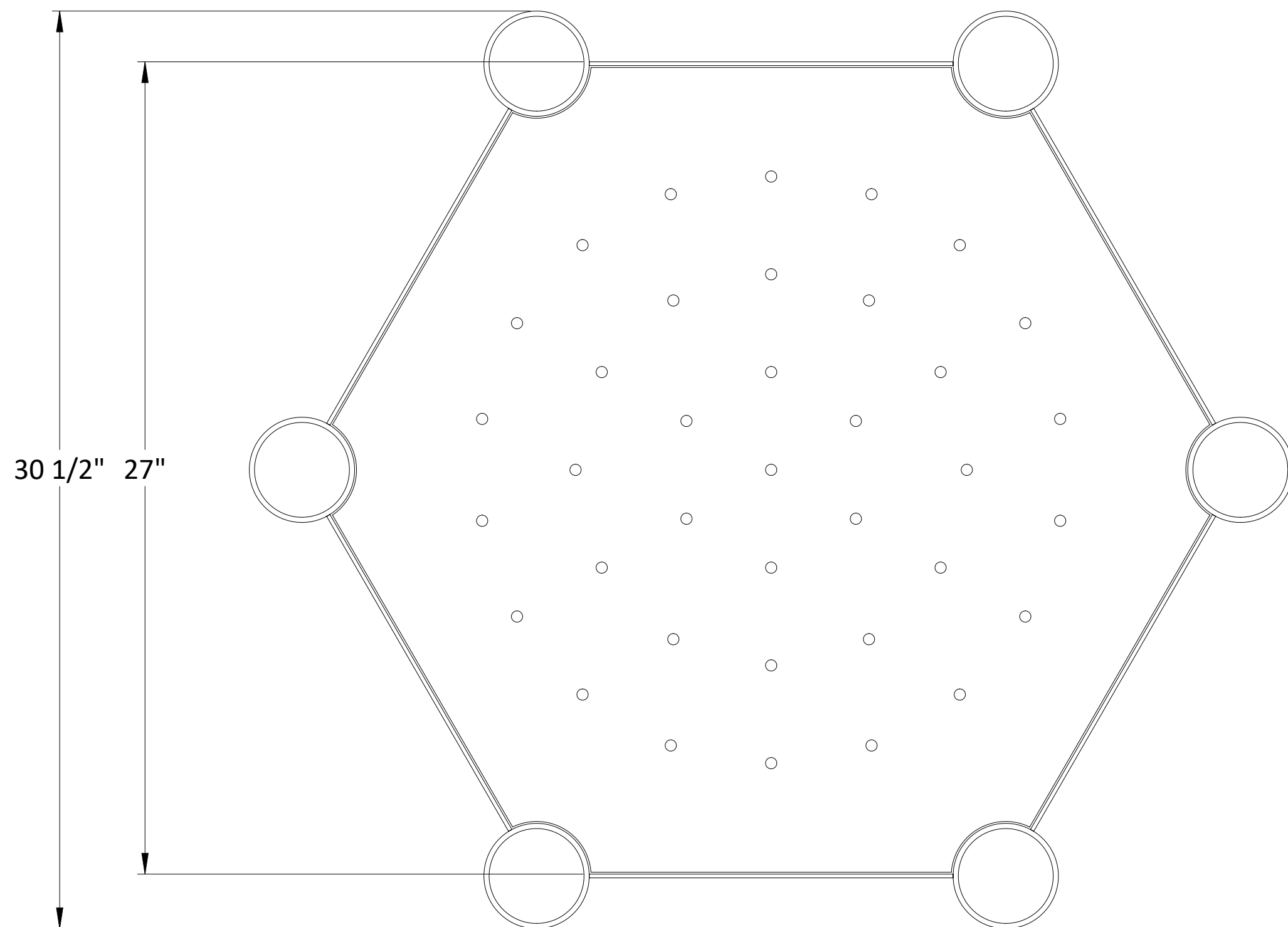

CUSTOM DESIGNS  
AVAILALE



The information included in this document is proprietary and shall not be reproduced, transferred, or disclosed to others, for any purpose whatsoever, without the written authorization of Quantum Design and Technologies Inc.

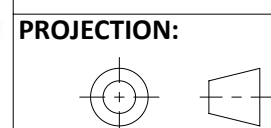

SHEET SIZE:  
**C**

DRAWN:	TP	PROJECT NAME:	HEX FIREPIT		WT:	125.8 lbs
CHECKED:	NB	PROJECT #:	QTMP 21-002	FINISH:	HIGH HEAT BBQ PAINT	
APP:	NB	TITLE:	2-VIEW			
DATE:	2021-12-20	SHEET 2 OF 3	DWG #:	QTMP 21-002 - 2		REV: 0

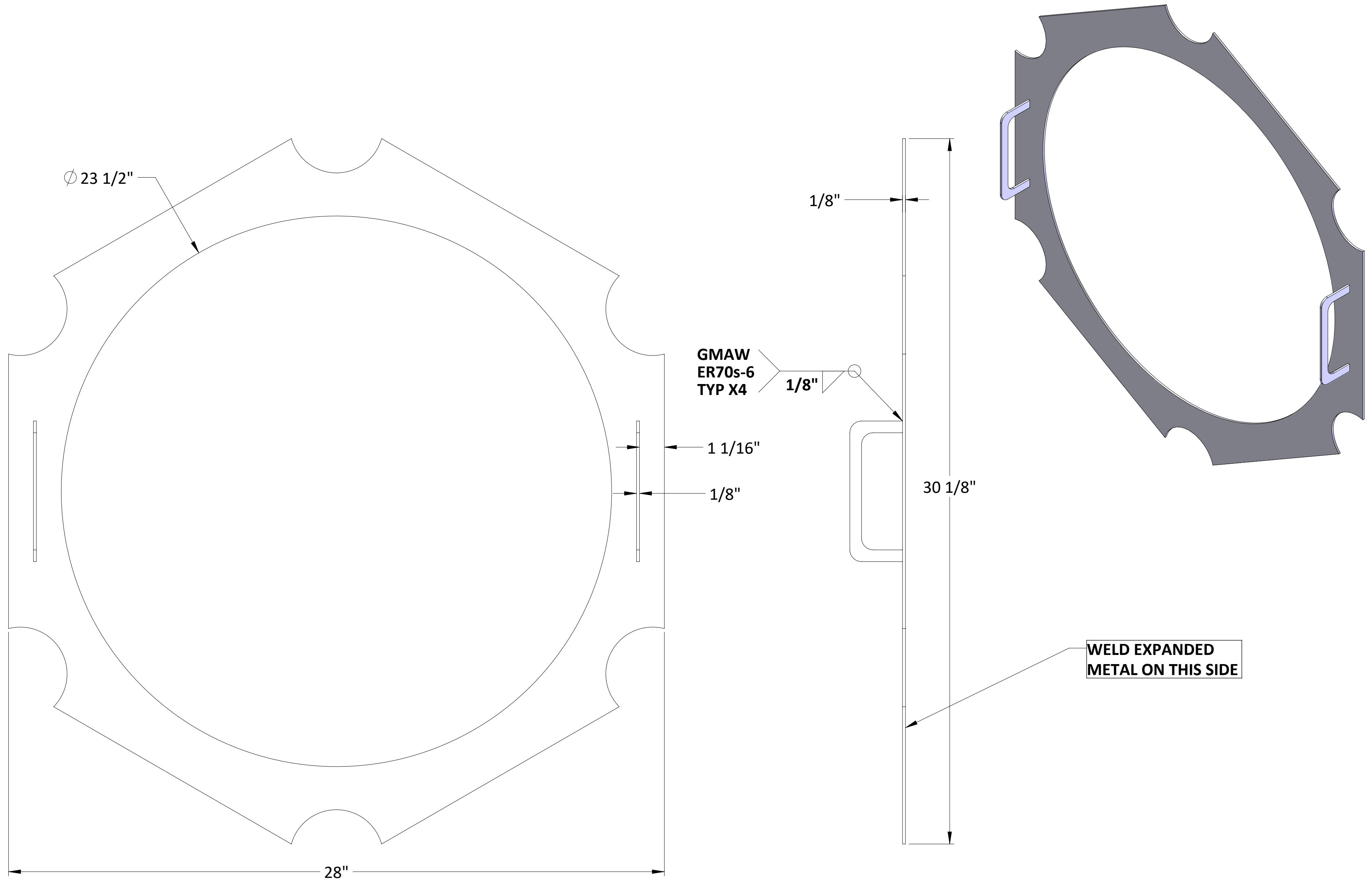

The information included in this document is proprietary and shall not be reproduced, transferred, or disclosed to others, for any purpose whatsoever, without the written authorization of Quantum Design and Technologies Inc.

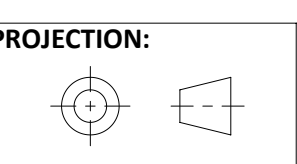

SHEET SIZE:  
**C**

DRAWN:	<b>TP</b>	PROJECT NAME:	<b>HEX FIREPIT</b>		WT:	<b>7.687 lbs</b>
CHECKED:	<b>NB</b>	PROJECT #:	<b>QTMP 21-002</b>	FINISH:	<b>HIGH HEAT BBQ PAINT</b>	
APP:	<b>NB</b>	TITLE:	<b>LID</b>			
DATE:	<b>2021-12-20</b>	SHEET 3 OF 3	DWG #:	<b>QTMP 21-002 - 3</b>		REV: <b>0</b>

ALL DIMENSIONS IN INCHES UNLESS OTHERWISE NOTED